



E-LINECR

MANUAL



E-LINECR





INDEX

Introduction	2
Unloading, Handling and Storage of Products	3
Handling and Lifting	4-5
Project Design	6
Horizontal & Vertical Cast Resin Busbar Applications	7
Suspension Components	8-11
Equipment Used	12
Horizontal Edgewise Mounting Application	13-14
Resin Application on Horizontal Edgewise During Assembly	15
Horizontal Mounting Application	16-17
Resin Application Horizontal During Assembly.....	18
Vertical Mounting Application	19-20
Resin Application Vertical During Assembly	21
Preparation of Joint Casting Material	22
Electrical site-tests	23
Junction Resistance Test Report	24
Line Insulation Resistance Test Report.....	25
Declaration	26
Certificates	27
Product Overview	28-29

Dear Customer,

EAE Elektrik A.S. Products are designed to provide the maximum benefit in efficiency and service. Our products are manufactured in accordance with IEC standards and EAE is quality assured to ISO 9001 standards in their modern production plants in Istanbul.

The components that you have purchased are manufactured by a completely environment conscious, that is ISO 14001 certified.

These instructions should be read carefully and acted upon before taking delivery of equipment on site.

Handling, installation and operation of busbar systems should be carried out only by skilled, trained and authorized personnel using all associated equipment such as rubber gloves, helmet, safety glasses or face shields and flash resistant clothing in accordance with established safety practices.

The busbar system's successful operation depends on correct handling, installation, operation and maintenance. Improper installation may cause personal injury and the failure of the busbar system and damage to other property.



Unloading:

- Forklift is the most reliable and easiest method for the unloading of the products from the container or the truck arriving at the worksite.
- Utmost care is required to be exercised to ensure avoidance of any harm that can be sustained by the products during the unloading process.

Storage:

- From the packing list check the number of pallets received, the number, dimensions and the condition of the busbar lengths. Advise any discrepancies immediately to the local EAE representative.
- All products should be stored in a dry environment. The casting materials for the joint must be stored at a temperature between 5 °C and 25 °C and not exposed to direct sunlight

Handling:

- Do not handle the materials using steel ropes or hooks. As shown in the cast resin busbar should be lifted using lifting straps placed at each end of the busbar length.
- Short modules may be lifted using a single strap providing that the piece is balanced.
- A wooden spacer should be used every 1.5m when storing the lengths placed on top of each other.
- Do not stack more than 5 modules on each other horizontally.

► Joint Area General Information

Joint Area Processing and Casting:

- Wait for a while before process.
- For vertical applications the mould sides should be tightened or supported to prevent the mould slipping down.
- Type C hardener shall be used if the ambient temperature is 5 to 15 °C; and type B shall be used if the ambient temperature is 15 to 35 °C.
- The expiry dates of the resin and hardener should be checked. They should not be used if the expiry date has passed.
- Ensure that the sand additive is dry.
- The mixture should be stirred for at least 5 minutes until thoroughly mixed.
- The mixture should be poured into the joint to the top of the mould, it should not be allowed to overflow.
- Joint moulds may be removed after 3 hours at 25 °C, 4 hours at 15 °C and 6 hours at 5 °C.
- Inside of the joint mould material shall be cleaned with a cloth; do not use a solvent or a metal cutting tool.

Pre-Cast Controlling of Juncture Area:

- The final check form supplied should be completed for each busbar joint installed.
- Perform a megger test after each joint, and ensure that there is no problem on the joint area.
- In order to prevent damage to the terminals and transformers during this test, remove their connections or protect them.
- After every electrical test, the system must be discharged to earth.
- After completing all electrical tests, make the terminal, MCCB and fuse connections again.
- The form filled in after each test should be submitted to the EAE representative. The product quality approval form (186) should be completed and submitted to us to validate the warranty.

Strapping type ropes should only be used instead of round ropes to prevent the materials slipping during handling.

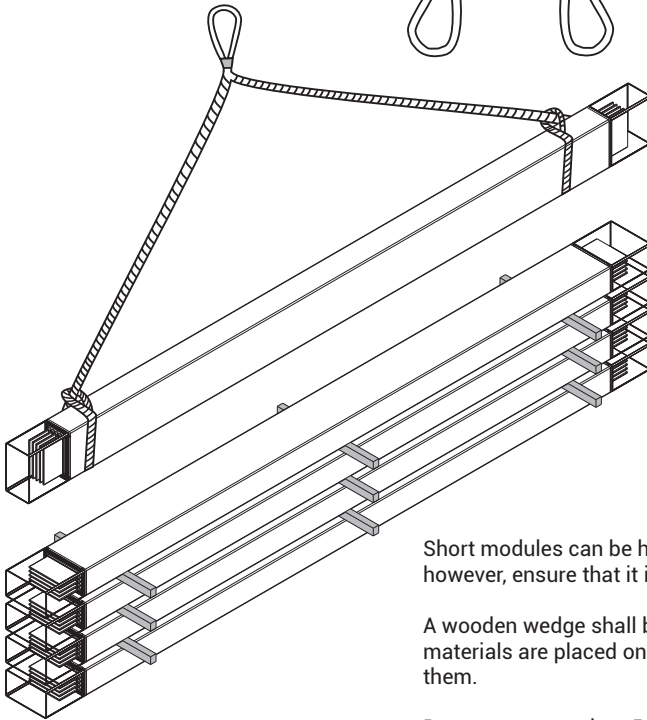
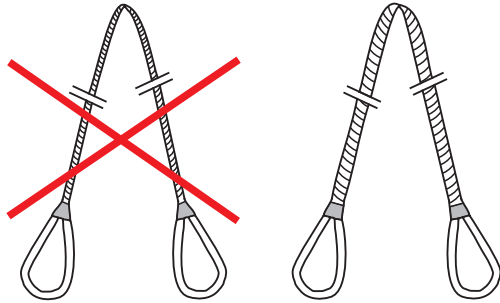

Short modules can be handled by a single rope, however, ensure that it is balanced.

A wooden wedge shall be used every 1.5 m when the materials are placed on each other while storing them.

Do not put more than 5 modules on each other horizontally.

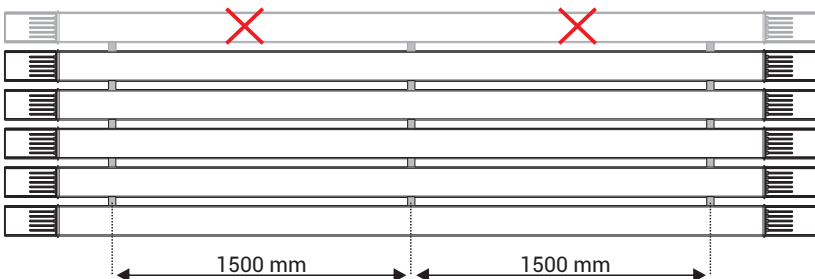

Introduction:

This installation manual includes the details of safe and quick handling and installation of cast resin busbar product. It shall be read carefully before starting the procedures on the product and relevant steps shall be followed.

Things To Do:

1. Read the info note on the pallet; lift and handle the the product as shown in "Figure 1" taking the pallet weight into consideration.
2. Product shall be hanged and lifted as shown in "Figure 2" while it is handled. (Figure 2)
3. Resin and hardener shall be stored as shown in Figure 3
4. Busbar route shall be marked before starting the installation.
5. Installation shall start from a single point (preferably panel) and shall be completed with the last module.
6. Do not perform casting before performing megger test on the joint and observing infinite resistance as the result of the test.
7. Do not apply expired joint casting agent.

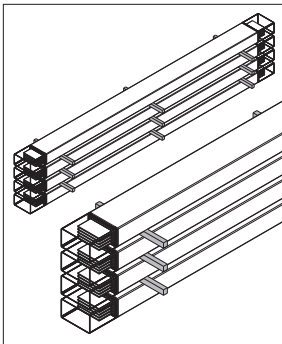

Figure 1

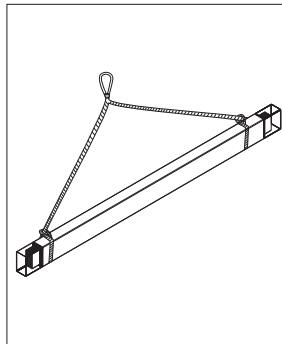

Figure 2

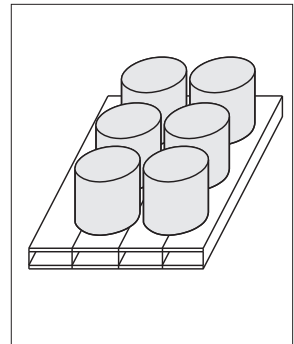
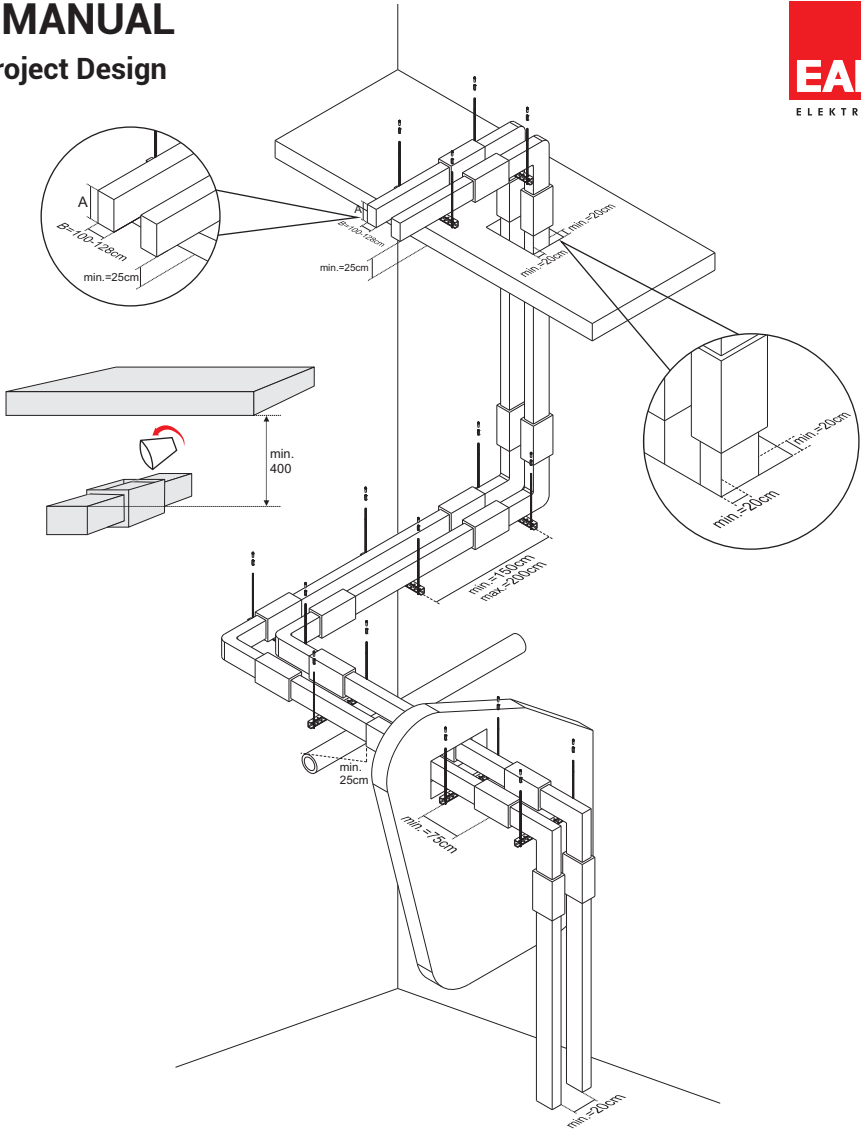

Figure 3



CRA - Al Conductor	Rated Current (A)	630	800	1000	1250	1600	2000	2500	2250	2500	-	3000	3200	3600	4000	5000
	Busbar Code	06	08	10	12	16	20	25	23	27	-	30	33	36	40	50
CRC - Cu Conductor	Rated Current (A)	800	1000	1250	1600	2000	2500	-	3000	3200	3600	4000	-	5000	-	6300
	Busbar Code	08	10	12	16	20	25	-	30	32	36	40	-	50	-	63
A	(mm)	90	105	130	160	210	250	300	310	340	370	410	430	490	590	730

⚠ In multipath busbars in high-rise vertical shaft applications; Due to floor heights, floor thickness and product tolerances, the window or additional point alignments on the upper floors may not be the same. In order for the Tap off boxes to be aligned and the joint point not to coincide with the floor transitions, the assembly should be continued by making measurements on each floor.

■ EAE is not responsible for the potential risks that may occur in cases where the products in our catalogue are used outside of the standard phase sequences as shown in the catalogue.

FIGURE 1 - EDGEWISE APPLICATION

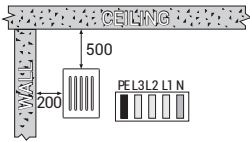
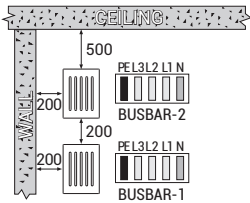
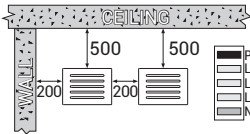

FIGURE 2 - EDGEWISE APPLICATION



Primarily on the installation phase; **BUSBAR-1** line should be installed before **BUSBAR-2** line.

FIGURE 3 - FLATWISE APPLICATION



Primarily on the installation phase; **BUSBAR-1** line should be installed before **BUSBAR-2** line.

FIGURE 4 - CROSSING UNDER A BEAM ON EDGEWISE APPLICATION

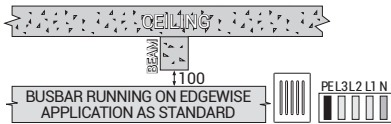

FIGURE 5 - CROSSING UNDER A BEAM ON FLATWISE APPLICATION

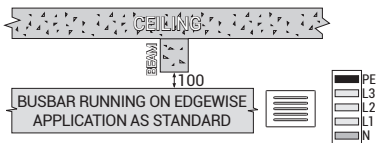

FIGURE 6 - SAMPLE WALL CROSSING WITH FIRE BARRIER

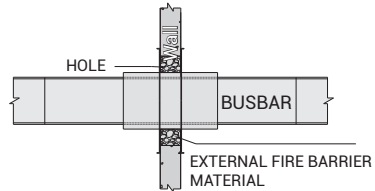

FIGURE 7 - STANDARD WALL CROSSING

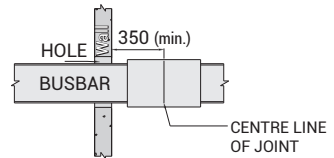

FIGURE 8 - EDGEWISE TRENCH APPLICATION

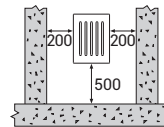

FIGURE 9 - FLATWISE TRENCH APPLICATION

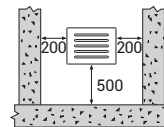
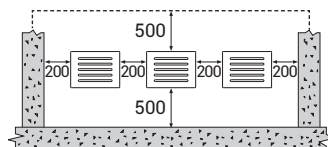

FIGURE 10 - FLATWISE TRENCH APPLICATION



Attention!

- For correct installation, the dimension from the busbar to the ceiling should not be less than 500mm
- He joint should be not come across to Beams.
- The dimensions given above are minimum values.
- All dimensions are given in mm.

► SUPPORTS

CR-UT HANGER SET FOR EDGEWISE APPLICATION (STANDARD APPLICATION)

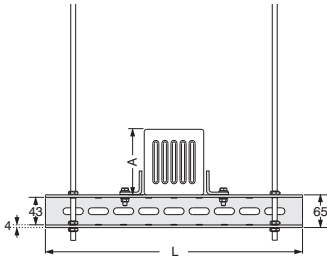
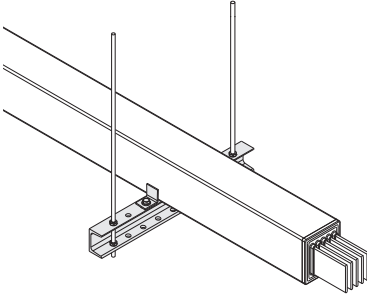

CRA - Al Conductor		CRC - Cu Conductor		Conductor Cross Section	L (mm)	A (mm)	Order Code
Rated Current	Busbar Code	Rated Current	Busbar Code				
630	06	800	08	6x40	300	90	3025348
800	08	1000	10	6x55	300	105	3025348
1000	10	1250	12	6x80	300	130	3025348
1250	12	1600	16	6x110	350	160	3025348
1600	16	2000	20	6x160	400	210	3025348
2000	20	2500	25	6x200	400	250	3025348
2500	25	-	-	6x250	400	300	3025348

CR-UT HANGER SET FOR FLATWISE APPLICATION (NON-STANDARD APPLICATION)

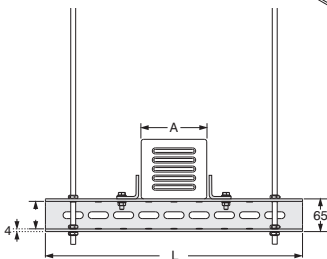
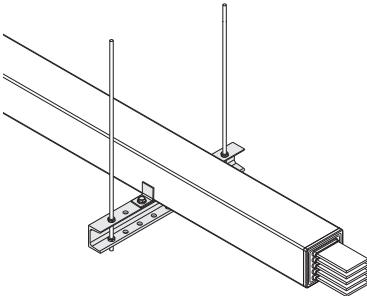

CRA - Al Conductor		CRC - Cu Conductor		Conductor Cross Section	L (mm)	A (mm)	Order Code
Rated Current	Busbar Code	Rated Current	Busbar Code				
630	06	800	08	6x40	350	90	3025347
800	08	1000	10	6x55	350	105	3025347
1000	10	1250	12	6x80	350	130	3025347
1250	12	1600	16	6x110	350	160	3025347
1600	16	2000	20	6x160	350	210	3025347
2000	20	2500	25	6x200	350	250	3025347
2500	25	-	-	6x250	350	300	3025347

■ *Flatwise Application is supplied for only on special conditions.

■ Please call us for non-standard dimensions.

► SUPPORTS

CR HANGER SET WITH BRACKETS FOR EDGEWISE APPLICATION (Standard Application)

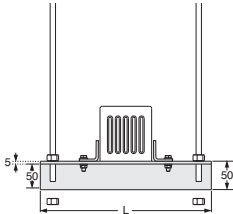
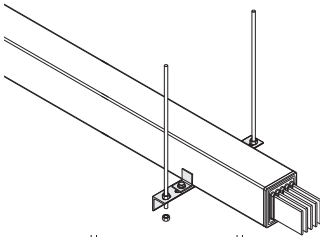

CR HANGER SET WITH BRACKETS FOR EDGEWISE APPLICATION (Non-Standard Application)

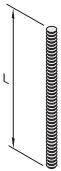
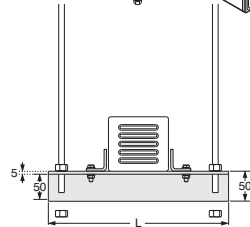
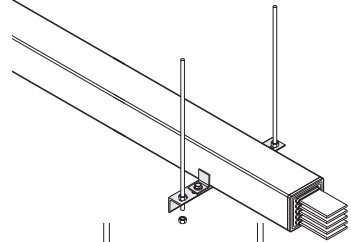

Threaded Rod



Extension Unit



Steel Dowel



Steel Nut



Washer

UAS-K5

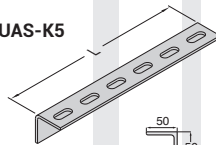

Diameter of the Hole to be drilled
M10.....Ø14
M12.....Ø16

Supports

Description	L (mm)	Order Code
UAS-K5 Support (1)	200	3005324
UAS-K5 Support (2)	250	3005323
UAS-K5 Support (3)	300	3005322
UAS-K5 Support (4)	350	3005321
UAS-K5 Support (5)	400	3005320
UAS-K5 Support (6)	500	3005319
UAS-K5 Support (7)	600	3005318
UAS-K5 Support (8)	700	3005317
UAS-K5 Support (9)	1100	3005316

Connection Units

Description	L (mm)	Order Code
BRA 14-05 Threaded Rod (M12)	500	5000026
BRA 14-10 Threaded Rod (M12)	1000	1004312
BRA 13 Extension Unit (M12)	-	5000023
BRA 9 Steel Dowel (M12)	-	5000022
M10 Steel Nut	-	1000522
M12 Steel Nut	-	1000964
M10 Washer	-	1000504
M12 Washer	-	1000505

■ Please call us for non-standard dimensions.

► SUPPORTS

IDY

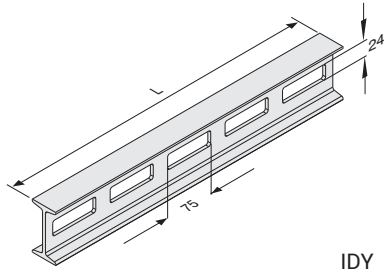

IDY

IDD

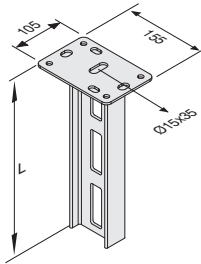

IDY

IDD

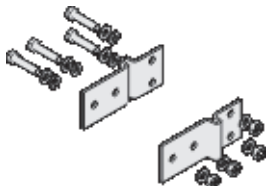

IDT

ORDER CODE
LENGTH L (mm)

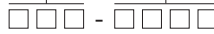

Description	L (mm)	Order Code
IDY 300	300	3008242
IDY 400	400	3008290
IDY 500	500	3008289
IDY 600	600	3008288
IDY 700	700	3008287
IDY 800	800	3008286
IDY 900	900	3008285
IDY 1000	1000	3008284
IDY 1100	1100	3008283
IDY 1200	1200	3008282
IDY 1300	1300	3008236
IDY 1400	1400	3008281
IDY 1500	1500	3008280
IDY 1600	1600	3008241
IDY 1700	1700	3008240
IDY 1800	1800	3008239
IDY 1900	1900	3008238
IDY 2000	2000	3008237

Description	L (mm)	Order Code
IDD 300	300	3008314
IDD 400	400	3008313
IDD 500	500	3008312
IDD 600	600	3008311
IDD 700	700	3008310
IDD 800	800	3008309
IDD 900	900	3008308
IDD 1000	1000	3008307
IDD 1100	1100	3008306
IDD 1200	1200	3008305
IDD 1300	1300	3008304
IDD 1400	1400	3008303
IDD 1500	1500	3008302
IDD 1600	1600	3008301
IDD 1700	1700	3008300
IDD 1800	1800	3008299
IDD 1900	1900	3008298
IDD 2000	2000	3008297

Description	L (mm)	Order Code
IDT Support Fitting	-	3008279

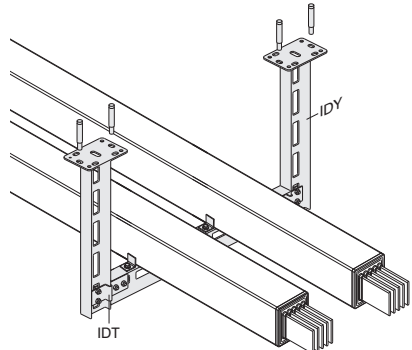

■ Please call us for non-standard dimensions.

► SUPPORTS

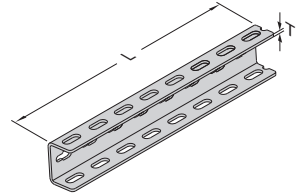
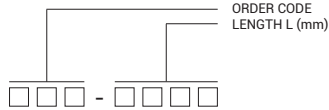
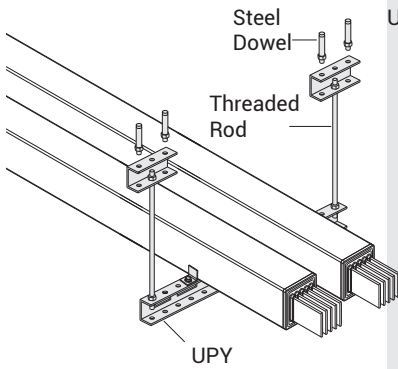

Description	T (mm)	L (mm)	Order Code
UPY 300	4	300	3004487
UPY 400	4	400	3004489
UPY 500	4	500	3004491
UPY 600	4	600	3004493
UPY 700	4	700	3004495
UPY 800	4	800	3004496
UPY 900	4	900	3004497
UPY 1000	4	1000	3004498
UPY 1100	4	1100	3004499
UPY 1200	4	1200	3004500
UPY 1500	4	1500	3004503

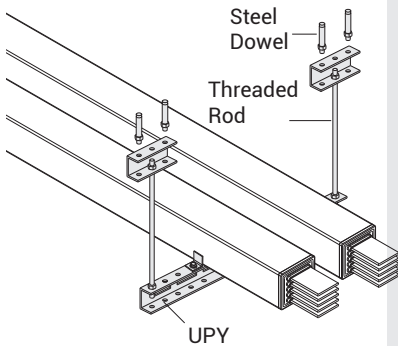

■ Please call us for non-standard dimensions.

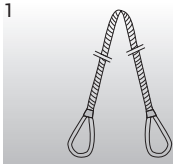

Fabric Crane Ropes

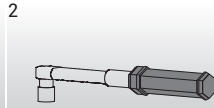

Torque Wrench

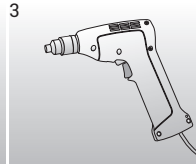

Hot Air Blower

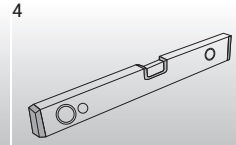

Spirit Level

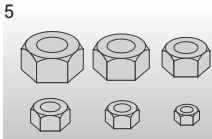

Nut Set

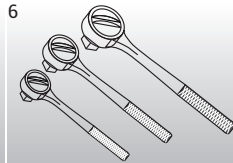

Socket Set

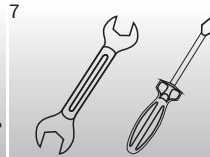

Wrench, Screwdriver



Lifting Device
(forklift truck, crane,
hoist etc.)

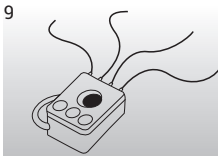

Megger Device

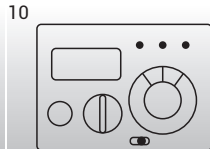

Dielectric Test Device
5 kV DC

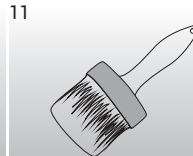

Paint Brush

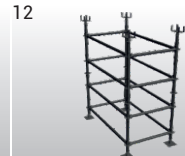

Scaffold

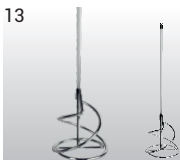

Mixer

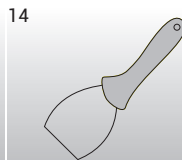

Putty knife

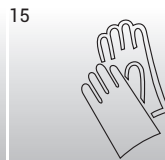

Protective Clothes,
Gloves, Goggles

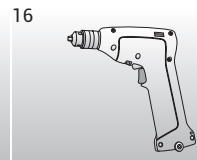

Drill

1

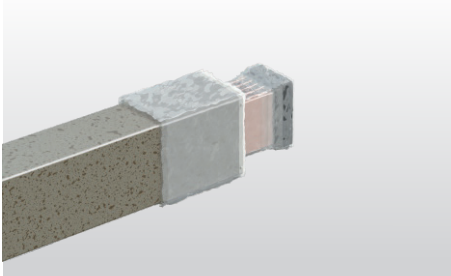

Stretch and head plastic at the tip of the busbar shall be removed.

2

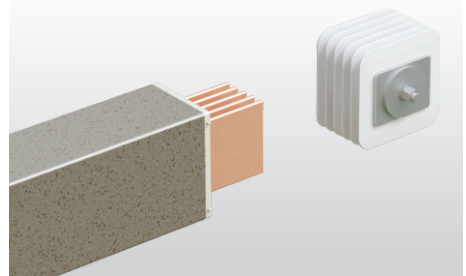

Tip parts exposed on the busbar are required to be cleaned with a clean and dry piece of cloth. After the completion of the cleaning process, the block joint and mounted on the stationary busbar. Block joint bolt shall be slightly tightened for not to falling

3

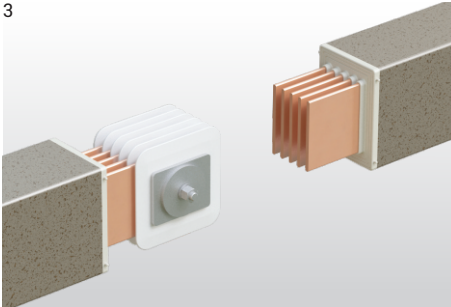

Second busbar is brought into alignment with the block joint. The block joint shall be loosened, and the second busbar shall be mounted on the stationary busbar. Bolt clearance is removed tightened slightly.

4

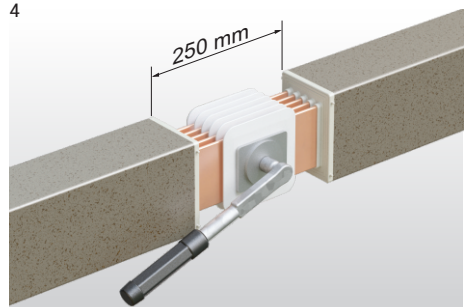

Coupled busbars and block joint shall be put into final form by looking at the alignments there of. Torqued with the torque wrench by setting to 83 Nm.

5

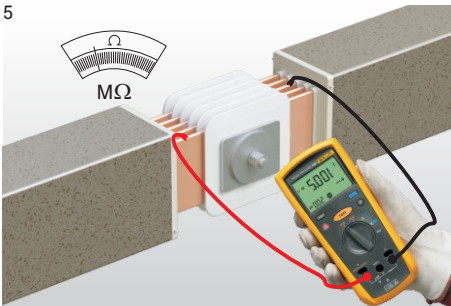

Megger test shall be conducted among the entire phases.

6

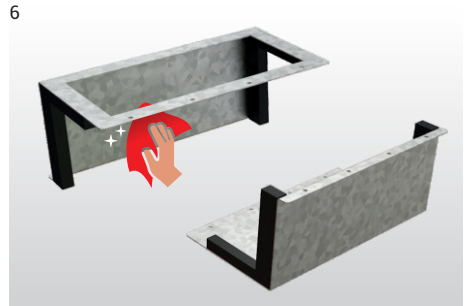

Inner surfaces of molds (surfaces subject to casting process) shall be cleaned with a clean and dry piece of cloth.

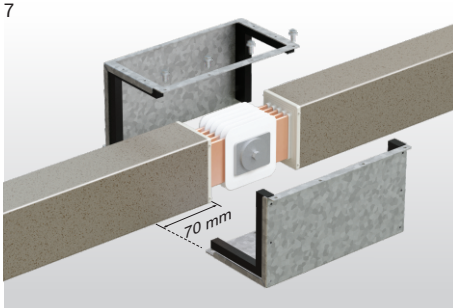

Block joint moulds shall be brought on the coupled busbars and affixed accordingly. Block joint moulds shall be secured on the trays with bolts with a distance of 70 mm from the tip of the busbar.



Alloy shall be casted uninterruptedly from the same spot.
(Please refer to page 22 for alloy preparation guide.)

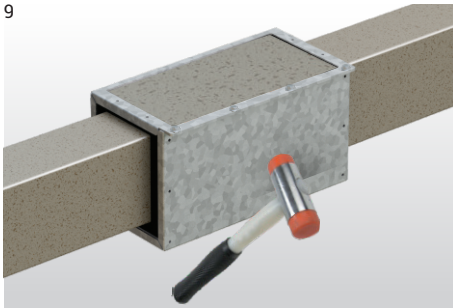

Vibration is provided by means of plastic hammer.

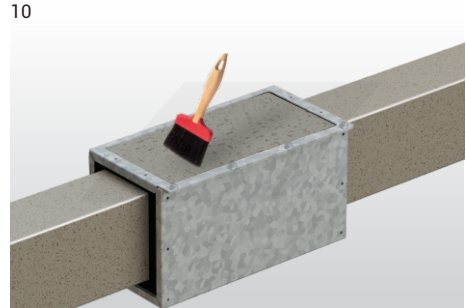

For each juncture, brushing for 2 minutes shall be performed once in every 10-15 minutes throughout 1 hour.

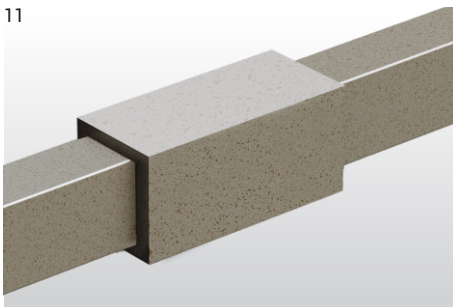

After the curing of the material (8-24 hours), casting mold shall be removed, and the sharpness of the part shall be smoothed accordingly. (Note: Varies depending on the seasonal conditions and temperature. Cold weather is disadvantageous.)

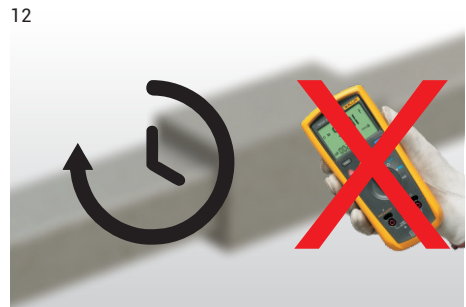

Megger test should not be conducted for a minimum of 24 hours after the casting process.

► Horizontal Application

After the entire adjustments are made, megger test and dielectric test shall be conducted on the busbar system coupled and absence of any stray voltage shall be ensured accordingly. Material prepared in buckets shall be casted on juncture area. Material casting shall be ensured not to have any clearance at all. After the completion of casting process, the material shall be ensured to be placed tightly by slightly hammering the block joint moulds.

- After the block joint mould is filled up to the upper level, the surface is required to be levelled out with a brush.
- For the purpose of expediting the air outlet after the completion of the casting process, vibration rendering process shall be applied on the mold for 8-10 minutes by a plastic hammer.
- Casting surface shall be brushed once in every 10-15 minutes and air bubbles forming shall be removed and the surface shall be smoothed accordingly.
- To remove the block joint mould, it shall be waited for curing process of 8-24 hours and the complete stiffening to be completed.
- In case of a requirement of more than 1 dose of application in the application of the juncture resin, it shall be performed successively without waiting for the application of the 2 and the 3 doses.

Note: Material for each joint shall be prepared separately and this prepared material shall be poured within 15 minutes.



1

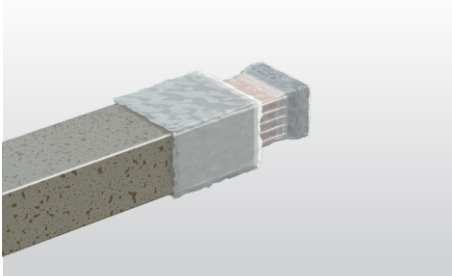

Stretch and head plastic at the tip of the busbar shall be removed.

2

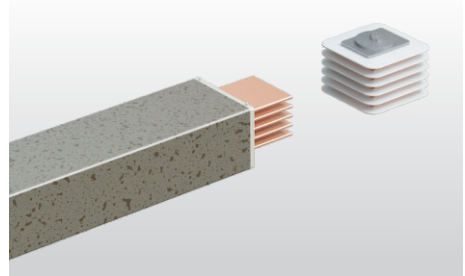

Tip parts exposed on the busbar are required to be cleaned with a clean and dry piece of cloth. After the completion of the cleaning process, it is aligned with the block joint tray and mounted on the stationary busbar. Block joint bolt shall be slightly tightened for not to falling.

3

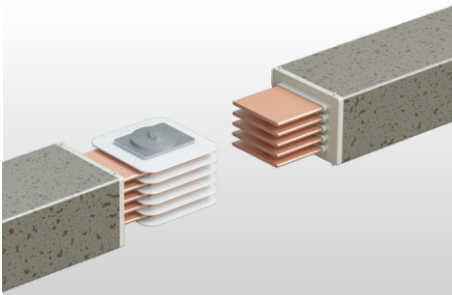

Second busbar is brought into alignment with the block joint. The block joint shall be loosened, and the second busbar shall be mounted on the stationary busbar. Bolt clearance is removed tightened slightly

4

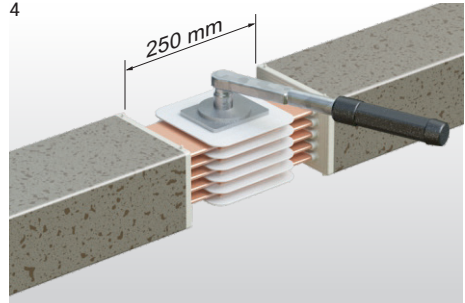

Coupled busbars and block joint shall be put into final form by looking at the alignments thereof. Torqued with the torque wrench by setting to 83 Nm.

5

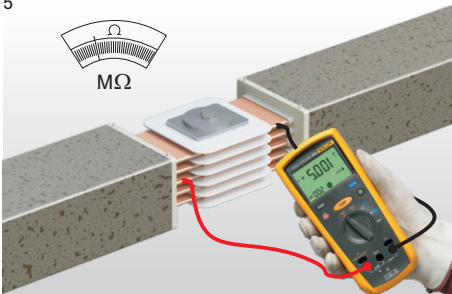

Megger test shall be conducted among the entire phases.

6

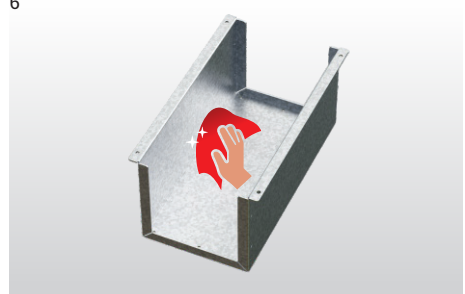

Inner surfaces of molds (surfaces subject to casting process) shall be cleaned with a clean and dry piece of cloth.

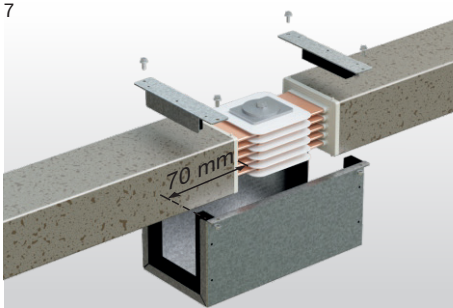

Block joint molds shall be brought on the coupled trays and affixed accordingly. Juncture molds shall be secured on the trays with bolts with a distance of 70 mm from the tip of the busbar.

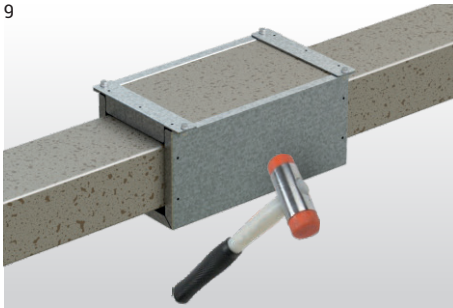

Vibration is provided by means of plastic hammer.



Alloy shall be casted uninterruptedly from the same spot. (Please refer to page 22 for alloy preparation guide.)

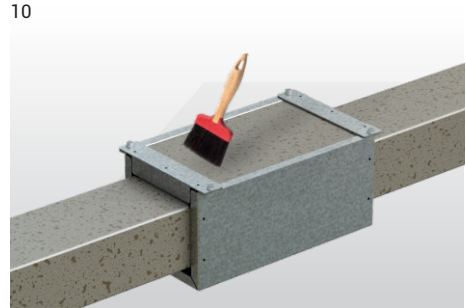

For each juncture, brushing for 2 minutes shall be performed once in every 10-15 minutes throughout 1 hour.

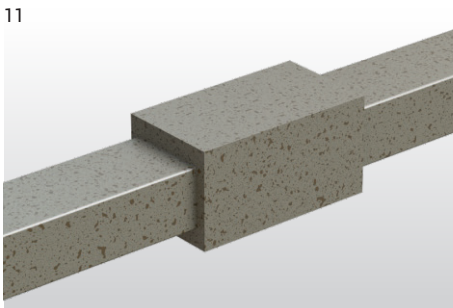

After the curing of the material (8-24 hours), casting mold shall be removed, and the sharpness of the part shall be smoothed accordingly. (Note: Varies depending on the seasonal conditions and temperature. Cold weather is disadvantageous.)

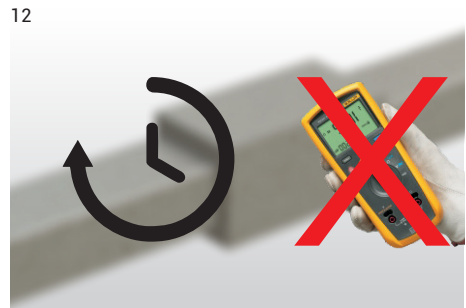

Megger test should not be conducted for a minimum of 24 hours after the casting process.

► Horizontal Application

After the entire adjustments are made, megger test and dielectric test shall be conducted on the busbar system coupled and absence of any stray voltage shall be ensured accordingly. Material prepared in buckets shall be casted on juncture area. Material casting shall be ensured not to have any clearance at all. After the completion of casting process, the material shall be ensured to be placed tightly by slightly hammering the block joint moulds.

- After the block joint mould is filled up to the upper level, the surface is required to be levelled out with a brush.
- For the purpose of expediting the air outlet after the completion of the casting process, vibration rendering process shall be applied on the mold for 8-10 minutes by a plastic hammer.
- Casting surface shall be brushed once in every 10-15 minutes and air bubbles forming shall be removed and the surface shall be smoothed accordingly.
- To remove the juncture mold, it shall be waited for curing process of 8-24 hours and the complete stiffening to be completed.
- In case of a requirement of more than 1 dose of application in the application of the juncture resin, it shall be performed successively without waiting for the application of the 2 and the 3 doses.

Note: Material for each joint shall be prepared separately and this prepared material shall be poured within 15 minutes.



1

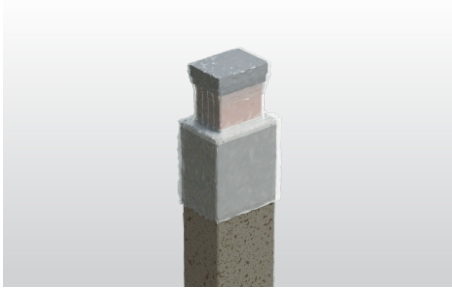

Stretch and head plastic at the tip of the busbar shall be removed.

2

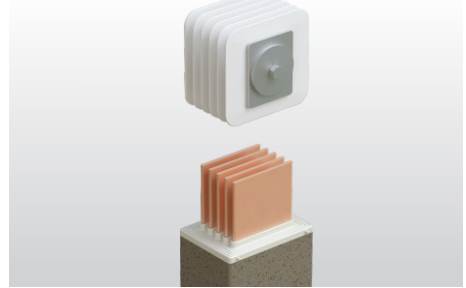

Tip parts exposed on the busbar are required to be cleaned with a clean and dry piece of cloth. After the completion of the cleaning process, it is aligned with the block joint tray and mounted on the stationary busbar. Block joint bolt shall be slightly tightened for not to falling.

3

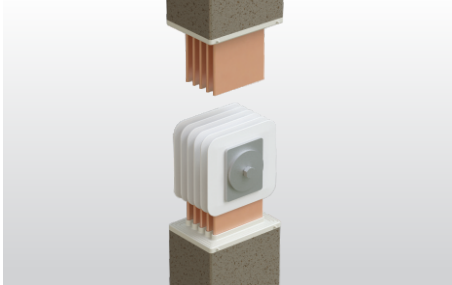

Second busbar is brought into alignment with the block joint. The block joint shall be loosened, and the second busbar shall be mounted on the stationary busbar. Bolt clearance is removed tightened slightly.

4

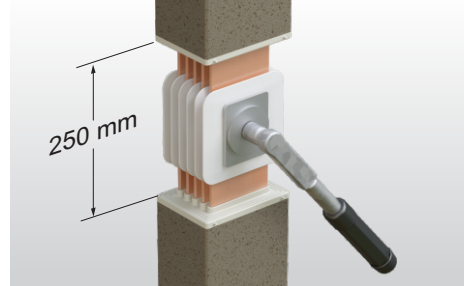

Coupled busbars and block joint shall be put into final form by looking at the alignments there of. Torqued with the torque wrench by setting to 83 Nm.

5



Megger test shall be conducted among the entire phases.

6

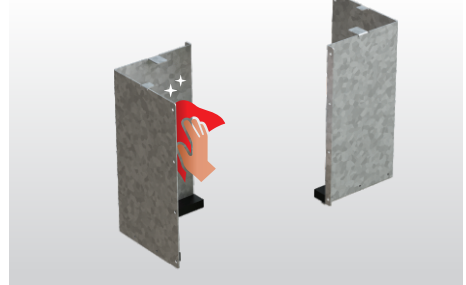

Inner surfaces of molds (surfaces subject to casting process) shall be cleaned with a clean and dry piece of cloth.

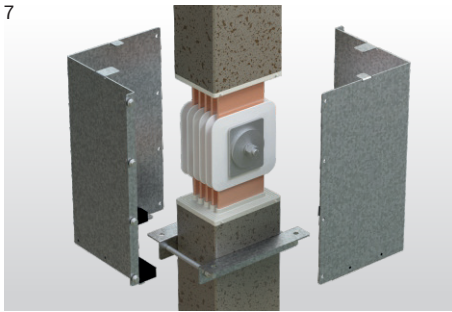

The support sheet delivered to assist that the block joint mold maintains its position shall be affixed. Block joint molds shall be brought on the support sheet and secured by means of bolts in a manner that the gaskets shall be at the bottom.

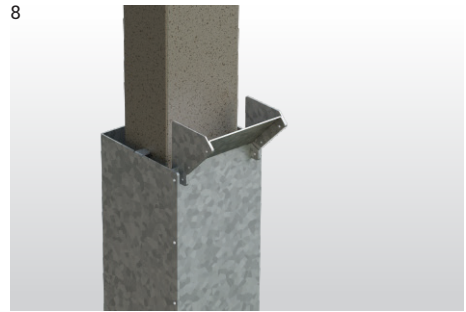

The alloy shall be casted uninterruptedly from the sheet that are delivered to assist the casting process from the same spot.
(Please refer to page 22 for alloy preparation guide.)



Vibration is provided by means of plastic hammer.



For each juncture, brushing for 2 minutes shall be performed once in every 10-15 minutes throughout 1 hour.



After the curing of the material (8-24 hours), casting mold shall be removed, and the sharpness of the part shall be smoothed accordingly.
(Note: Varies depending on the seasonal conditions and temperature. Cold weather is disadvantageous.)

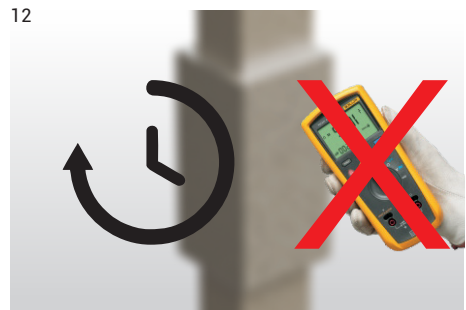

Megger test should not be conducted for a minimum of 24 hours after the casting process.

» Resin Application Vertical During Assembly

► Vertical Application

After the entire adjustments are made, megger test and dielectric test shall be conducted on the busbar system coupled and absence of any stray voltage shall be ensured accordingly. Material prepared in buckets shall be casted on juncture area. Material casting shall be ensured not to have any clearance at all. After the completion of casting process, the material shall be ensured to be placed tightly by slightly hammering the block joint moulds.

- After the block joint mould is filled up to the upper level, the surface is required to be levelled out with a brush.
- For the purpose of expediting the air outlet after the completion of the casting process, vibration rendering process shall be applied on the mold for 8-10 minutes by a plastic hammer.
- Casting surface shall be brushed once in every 10-15 minutes and air bubbles forming shall be removed and the surface shall be smoothed accordingly.
- To remove the block joint mould, it shall be waited for curing process of 8-24 hours and the complete stiffening to be completed.
- In case of a requirement of more than 1 dose of application in the application of the juncture resin, it shall be performed successively without waiting for the application of the 2 and the 3 doses.

Note: Utmost care should be exercised for the alignments in vertical applications. Otherwise, clearances may form on the upper part to risk the juncture accordingly.



►►Preparation of Joint Casting Material

Megger test is definitely required to be conducted prior to the casting process.

Resin (A), Hardener (B) and fillers; must be stored at least one day over (> 20 °C).

Ambient temperature of job side must be 5°C < T amb < 40°C

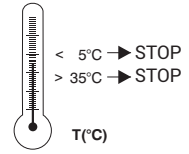
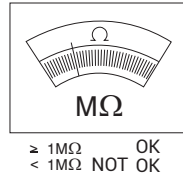

Preparation of Mixture



When determining the material to be consumed for joint point, the installation of joint point weighing 15 kg and its multiples should be included in the work plan for the same day. Otherwise, since the remaining material will happen a curing reaction, it cannot be used in another day's work plan and will be scrapped. Material planning should be done taking this detail into consideration.

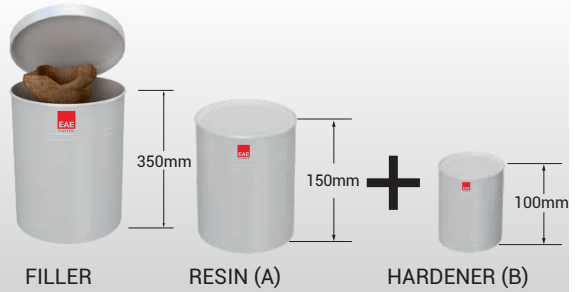

1



Filler removed from the plastic bucket.

2

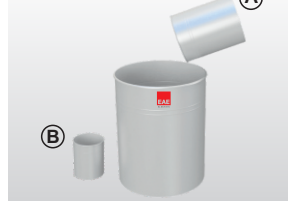

Resin and hardener are mixed in plastic bucket.

3



4



Mix resin and hardener thoroughly with stirrer at least 30-60 seconds.

5



Add fillers and mix until homogeneous; at least 2-3 minutes. Then application must be done within 15 minutes.

► Junction Resistance Test

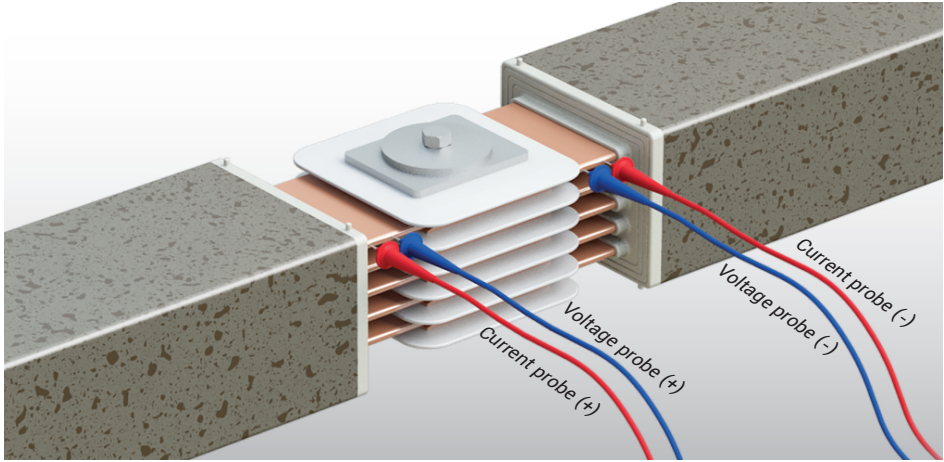

$$R_{\text{maks}} \leq 15 \mu\Omega$$

► Line Insulation Resistance Test

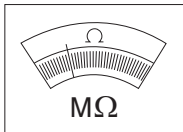
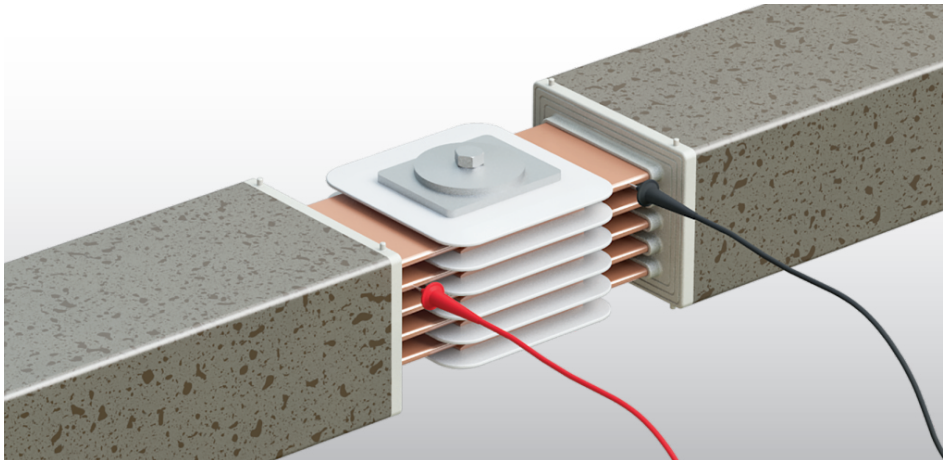

≥ 1MΩ OK
< 1MΩ NOT OK

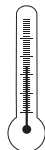

< 5°C → STOP
> 35°C → STOP

T(°C)

PURPOSE

Joint resistance must be measured to ensure contact quality and to prevent the busbar from overheating during operation. The purpose is to measure the joint resistances of CR type of busbars' of EAE branded.

SCOPE

This test instruction covers CR type of EAE branded busbars whose joint resistance is to be measured. Since the measurement of joint resistance is not defined in the relevant busbar standards, this test instruction has been prepared based on OHM law.

APPLICATION OF THE TEST

The OHM law is based on a four-wire measurement in this test: a constant current is injected and the resulting voltage drop is used to calculate the resistance.

Joint resistance measurement points for a representative joint connection are given in Figure 1.

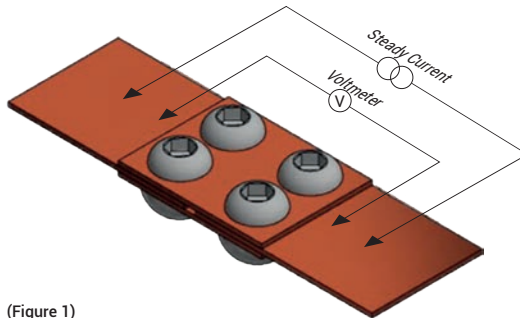

(Figure 1)

The diagram given in Figure 1 is a reference for joint resistance measurement for all kinds of joint connections.

Joint connections may differ in different product types, but basically, measurement in all joint structures is based on the same logic.

Joint structures of EAE busbars of CR model is shown in the drawing below.

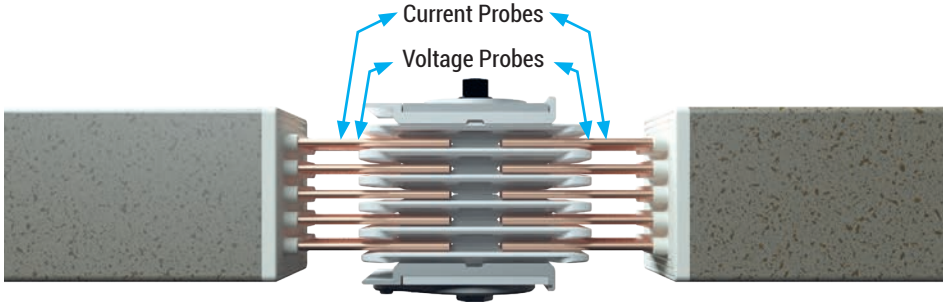

Measurements should be made with a four-wire DC low resistance.

The probes of the device should be connected to the joint structure as shown in Figure 1. A four-wire, calibrated OHM meter that applies at least DC 10 Amperes should be preferred.

The most suitable measuring probes should be used according to the joint structure.

As shown in Figure 1, joint resistance measurements are made after the measurement probes are connected to the joint connection.

Joint transition resistance measurements are repeated at least twice to ensure the measurement result.

The difference in resistance value measured for L1, L2, L3 and N conductors in the same joint can not be more than 10 $\mu\Omega$.

Joint transition resistance measured for PE conductor can not be more than 100m Ω .

Maximum joint transition resistance is 25 $\mu\Omega$. All values below this value are considered acceptable.

►►EAE Electrical Site Test Report Junction Resistance Test Report



Customer :		Date:/...../.....
Project:		Order No:
Address:		U _n : V	I _n : A
Busbar Code:		Material: AL <input type="checkbox"/> CU <input type="checkbox"/>	Conductor section: x mm ²
Line:		Required Torque:	M12 83Nm
Note: The tests have to perform only with calibrated devices.			Calibration Date:/...../.....

Results									
Junction:		Junction:		Junction:		Junction:		Junction:	
Phase	R (μΩ)	Phase	R (μΩ)	Phase	R (μΩ)	Phase	R (μΩ)	Phase	R (μΩ)
N - N		N - N		N - N		N - N		N - N	
L1 - L1		L1 - L1		L1 - L1		L1 - L1		L1 - L1	
L2 - L2		L2 - L2		L2 - L2		L2 - L2		L2 - L2	
L3 - L3		L3 - L3		L3 - L3		L3 - L3		L3 - L3	
PE - PE		PE - PE		PE - PE		PE - PE		PE - PE	
Torque: Nm	Torque: Nm	Torque: Nm	Torque: Nm	Torque: Nm
Mak. Value: μΩ	Mak. Value: μΩ	Mak. Value: μΩ	Mak. Value: μΩ	Mak. Value: μΩ

Junction:		Junction:		Junction:		Junction:		Junction:	
Phase	R (μΩ)	Phase	R (μΩ)	Phase	R (μΩ)	Phase	R (μΩ)	Phase	R (μΩ)
N - N		N - N		N - N		N - N		N - N	
L1 - L1		L1 - L1		L1 - L1		L1 - L1		L1 - L1	
L2 - L2		L2 - L2		L2 - L2		L2 - L2		L2 - L2	
L3 - L3		L3 - L3		L3 - L3		L3 - L3		L3 - L3	
PE - PE		PE - PE		PE - PE		PE - PE		PE - PE	
Torque: Nm	Torque: Nm	Torque: Nm	Torque: Nm	Torque: Nm
Mak. Value: μΩ	Mak. Value: μΩ	Mak. Value: μΩ	Mak. Value: μΩ	Mak. Value: μΩ

The maximum values per type and explanation to execute this test can be found in Annex A Electrical Site Tests of CR Manuel

Remarks			

Witnesses			
Name	Company	Date	Signature

Customer:		Date:/...../.....
Project:		Order No:
Address:		U _s : V	I _s : A
Busbar Code:		Material: AL <input type="checkbox"/> CU <input type="checkbox"/>	Conductor Section: x mm ²
Line:		Result by: V (DC)
Note: The tests have to perform only with calibrated devices.			Calibration Date:/...../.....

Recommended Test Voltage 1000V DC

Sonuçlar

	Before Casting	After Casting	
N - L1	=	/	MΩ
N - L2	=	/	MΩ
N - L3	=	/	MΩ
N - PE	=	/	MΩ
L1 - L2	=	/	MΩ
L1 - L3	=	/	MΩ
L1 - PE	=	/	MΩ
L2 - L3	=	/	MΩ
L2 - PE	=	/	MΩ
L3 - PE	=	/	MΩ

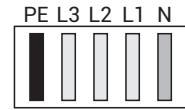

Standard Conductor Configuration

Remarks

Witnesses

Name	Company	Date	Signature

CE DECLARATION OF CONFORMITY

Product Group E-Line CR Busbar Energy Distribution System

Manufacturer EAE Elektrik Asansor End. Insaat San. ve Tic. A.S.
Akcaburgaz Mahallesi, 3114. Sokak,
No:10 34522 Esenyurt-Istanbul

The objects of the declaration described below is in conformity with the relevant Union harmonisation legislation. This declaration of conformity is issued under the sole responsibility of the manufacturer.

Standard :

EN 61439-6
Low-voltage switchgear and controlgear assemblies - Part 6: Busbar trunking systems

CE - Directive

2014/35/EU "The Low Voltage Directive"

2014/30/EU "Electromagnetic Compatibility (EMC) Directive"

2011/65/EU "Restriction of the use of certain hazardous substances (RoHS)"

Technical Document Preparation Official ;

EAE Elektrik Asansor End. Insaat San. ve Tic. A.S.
Akcaburgaz Mahallesi, 3114. Sokak, No:10 34522 Esenyurt-Istanbul

Mustafa AKÇELİK

Date

20.04.2024

Document Authorized Signatory

Elif Gamze KAYA OK
Deputy General Manager



	<p>CERTIFICATE</p> <p>EAE Elektrik San. ve T. Akçaburgaz Mal 34510 Esenyurt Turkey</p>	
<p>For the product:</p>	<p>Low-voltage busbar trunking system</p>	
<p>Trade name:</p>	<p>EAE</p>	
	<p>CRA06</p> <p>Ue 1000 V, Ui 1100 V, IP68, IK: 50J, for 1000 V, Icw 20 kA – 1 s</p> <p>EAE Elektrik San. ve T. Akçaburgaz Mal 34510 Esenyurt Turkey</p> <p>Design verification</p> <p>IEC 61439-6: 2011, 6.10.2.7, 10.2.10.10, 10.11 and Annex BB, CC, and DD</p>	
<p>Remarks:</p>	<p>Busbar trunking system consists of flange, joint and straight lengths</p>	
	<p>is granted on accordance with IEC 61439-6: 2011, 6.10.2.7, 10.2.10.10, 10.11 and Annex BB, CC, and DD</p> <p>Attestation does not cover production with the same design</p> <p>13</p>	
<p>DEKRA Certification B.V.</p>	<p>DEKRA, the results of the product, submitted by the manufacturer, is not the responsibility of DEKRA.</p>	
	<p>ger</p> <p>this certificate and adjacent certificates</p> <p>Utrechtseweg 310, 6815 JH Utrecht, The Netherlands T +31 88 96 83100 www.dekra.com</p>	

630A ... 6300A COMPACT BUSBAR PRODUCT OVERVIEW (E-LINE CR)

1- Standards & Certification:

- Busbar trunking system shall be designed, type tested and, manufactured in accordance with the International standard IEC 61439-6. Type test shall be documented by independent and internationally accredited testing and certification bodies. Short circuit type tests shall be conducted by independent and accredited testing and certification bodies. Short circuit type tests and the following 3 main type tests shall be conducted for each current rating of the busbar system and conformity to the standards certificates obtained.

2- General Structure Of The System

The busbar system should be low impedance in accordance with the following characteristics. The tin coated conductors are arranged as a sandwich construction inside the resin body without any air gaps.

2.1-Electrical Characteristics

- Busbar systems nominal insulation voltage shall be 1000V
- As per ampere rates, minimum short circuit values shall be as given below;

For Aluminium Conductors;

630A :	1 sec/rms 20kA, Peak 40kA
800A :	1 sec/rms 28kA, Peak 58,8kA
1000A :	1 sec/rms 40kA, Peak 84kA
1250A :	1 sec/rms 55kA, Peak 121kA
1600-2000-2500A :	1 sec/rms 70kA, Peak 154kA
2250A :	1 sec/rms 100kA, Peak 220kA
3000A and above :	1 sec/rms 120kA, Peak 264kA

For Copper Conductors;

800A :	1 sec/rms 23kA, Peak 48,3kA
1000A :	1 sec/rms 32kA, Peak 67,2kA
1250A :	1 sec/rms 45kA, Peak 94,5kA
1600A :	1 sec/rms 60kA, Peak 132kA
2000-2500A :	1 sec/rms 80kA, Peak 176kA
3000A and above :	1 sec/rms 120kA, Peak 264kA

2,2- Housing

- The housing of the busbar system shall be manufactured with specially developed cast material.
- The structure of the busbar lengths shall have conductors tin plated along their complete length within the housing.
- Multi-path busbars should be combined in a single body so that they are not separated from each other.
- Up and down, right-left turn elements, "T" and offset elements, panel, transformer and cable connectors, termination, horizontal and vertical expansion elements should be standard in the Busbar trunking system. Special modules and different lengths busbar ducts that may be required during the application of the project must be manufactured in a short time in accordance with standard specifications and technology.
- If busbar runs pass through the building expansion joint a horizontal expansion element shall be used in the run. In addition horizontal expansion elements should be used every 40 m along a horizontal run.

2.3- Conductors and Phase Configuration

Aluminium or Copper conductors shall be tin plated at the joints upon the wire configuration and required numbers, which are described below.

- Busbar system shall have aluminium conductors between 630A-5000A
- Busbar system shall have copper conductors between 800A-6300A
- Busbar system shall have the following number of conductors and wire configuration.

- 3 Conductors
- 4 Conductors
- 5 Conductors

- Neutral conductor shall have the same cross section as the phase conductor cross section.
- Aluminium conductors shall be of EC grade aluminium. Minimum conductivity shall be 34m/mm².Ω. All surfaces of aluminium conductors shall be tin plated.
- Copper conductors shall be minimum 99,95% electrolytic copper. Minimum conductivity shall be 56m/mm².Ω. all surfaces of electrolytic copper conductors shall be tin plated.

2.4- Insulation

- Busbars shall be insulated using a mixture of specially selected silica and calcite mixed with an electrical grade epoxy resin to make a superior composite material. This insulation material must have a high impact resistance against external impacts.

2.5- Modular Joint Construction

- The busbar lengths must be joined together with the joint's point drawer type modular block joint system by placing the conductors in the conductive socket in the block insert. Joint block insulators should be high strength CTP insulators. The joint block's centre bolt should be tightened with a torque wrench set to 83 Nm (60 lb ft) after installation.

2.6- Protection

- Protection degree of the housing and joints shall be IP68.

3- Installation and Commissioning

The installation of the busbar system should be done in accordance with the type and current values shown in these plans in accordance with the electrical project, electrical single line schemes, layout plans and detailed busbar application projects, the manufacturer's installation instructions must be observed carefully during the assembly process. The central joint's bolts must be tightened with the appropriate torque wrench and the nut side of the bolt must be secured with the nut locking cap. After installation of the busbar system the installation should be checked for compliance with the manufacturer's instructions and the requirements of the project, an insulation test should be done. Insulation resistance between all conductors and body has to be bigger than 1 megaohm.



A series of 20 horizontal dashed lines spanning the width of the page, providing a template for handwritten notes or entries.

PRODUCT TYPES



BUSBAR ENERGY DISTRIBUTION SYSTEMS



CABLE TRAYS



TROLLEY BUSBAR ENERGY DISTRIBUTION SYSTEMS



INDOOR SOLUTIONS



SUPPORT SYSTEMS

Please visit our website for the updated version of our catalogues.
www.eaelectric.com



EAE Elektrik A.S.
Head Office
Akcaburgaz Mahallesi,
3114. Sokak, No:10 34522
Esenyurt - Istanbul - TURKEY
Tel: +90 (212) 866 20 00
Fax: +90 (212) 886 24 20

EAE DL 3 Factory
Busbar
Gebze IV Istanbul Makine ve
Sanayicileri
Organize Bolgesi, 6. Cadde,
No: 6 41455 Demirciler Koyu,
Dilovası - Kocaeli - TURKEY
Tel: +90 (262) 999 05 55
Fax: +90 (262) 502 05 69



CR Manuel EN Rev 05 0 pcs. 04/10/2024
D.S.

EAE has full right to make any revisions or changes on this catalogue without any prior notice.